

**M12 female 0° shielded B-cod. with cable, Profibus**

PVC 1x2xAWG24 shielded vt UL/CSA 1m

PROFIBUS

Female straight

M12, 2-pole

B-coded

shielded

Plastic housings with good resistance against chemicals and oils.

The resistance to aggressive media should be individually tested for your application. Further details on request.

Further cable lengths on request.

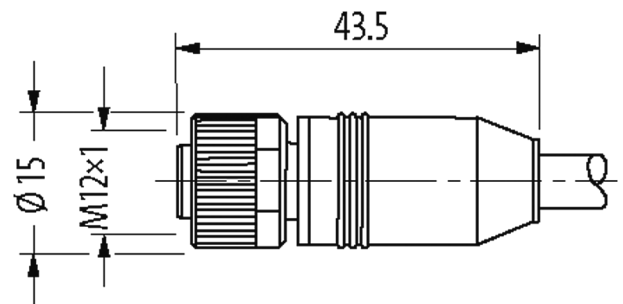
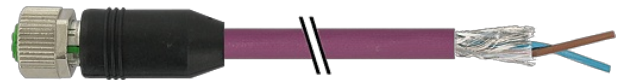
**Illustration**

Female



Product may differ from Image

**Approvals**

\* only for products with UL/CSA approved cable

cCSAus

**More Info**

**Form**

Form 14061

**Cables**

No./diameter of wires	1 × 2 × 0.25 mm <sup>2</sup>
Wire isolation	PE (rd, gn)
C-track properties	2 Mio.
Material (jacket)	PVC (UL)
Outer Ø	7.8 mm ±5%
Bend radius (moving)	12× outer Ø
Temperature range (fixed)	-25...+70 °C
Temperature range (mobile)	-20...+50 °C
Cable identification	850
Cable weight [g/m]	75,90
Material (wire)	Cu wire, bare
Resistor (core)	max. 68 Ω/km (20 °C)
Single wire Ø (core)	0.13 mm
Construction (core)	19× 0.13 mm
Diameter (core)	1 × 2 × 0.25 mm <sup>2</sup>
AWG	similar to AWG 24
Material (wire isolation)	PE
Wire-Ø incl. isolation	2.55 mm ±5%
Color/numbering of wires	rd, gn
Shield	yes
	min. 70%
Material (jacket)	PVC
Outer-Ø (jacket)	7.8 mm ±5%
Color (jacket)	violet
Nominal voltage	30 V AC
Test voltage	1.5 kV
Temperature range (fixed)	-25...+70 °C
Temperature range (mobile)	-20...+50 °C
Bend radius (fixed)	7.5× outer Ø
Bend radius (moving)	12× outer Ø
No. of bending cycles (C-track)	max. 2 Mio. (25 °C)
Traversing distance (C-track)	max. 5 m (horizontal)
Travel speed (C-track)	max. 3 m/s
Acceleration (C-track)	max. 5 m/s <sup>2</sup>
Jacket Color	violet

**Technical Data**

Operating voltage	max. 60 V AC/DC
Operating voltage (only UL listed)	max. 30 V AC/DC
Rated surge voltage	1.5 kV
Operating current per contact	max. 4 A
Material group	IEC 60664-1, category I
Coding	B-coded
Locking of ports	Screw thread (M12×1 mm) recommended torque 0.6 Nm, self-securing

Compression gland	M12 (SW13)
Protection	IP65, IP66K, IP67 inserted and tightened (EN 60529)
Locking material	Zinc die casting, matte nickel plated
Material	PUR

**General data**

Standards	DIN EN 61076-2-101 (M12)
Pollution Degree	3
Stripping length (jacket)	20 mm
Temperature range	-25...+85 °C, depending on cable quality

**Commercial data**

country of origin	DE
customs tariff number	85444290
EAN	4048879545693
eClass	27061801
Packaging unit	1